

Smart Lock User Manual



Special Attention:

1. Mechanical keys please keep outdoor, just in case keys lock in doors.
2. Please charge for the battery when low wattage alarm.
3. Reading this manual carefully before installation, and keep it for future reference.

1. Lock Structure

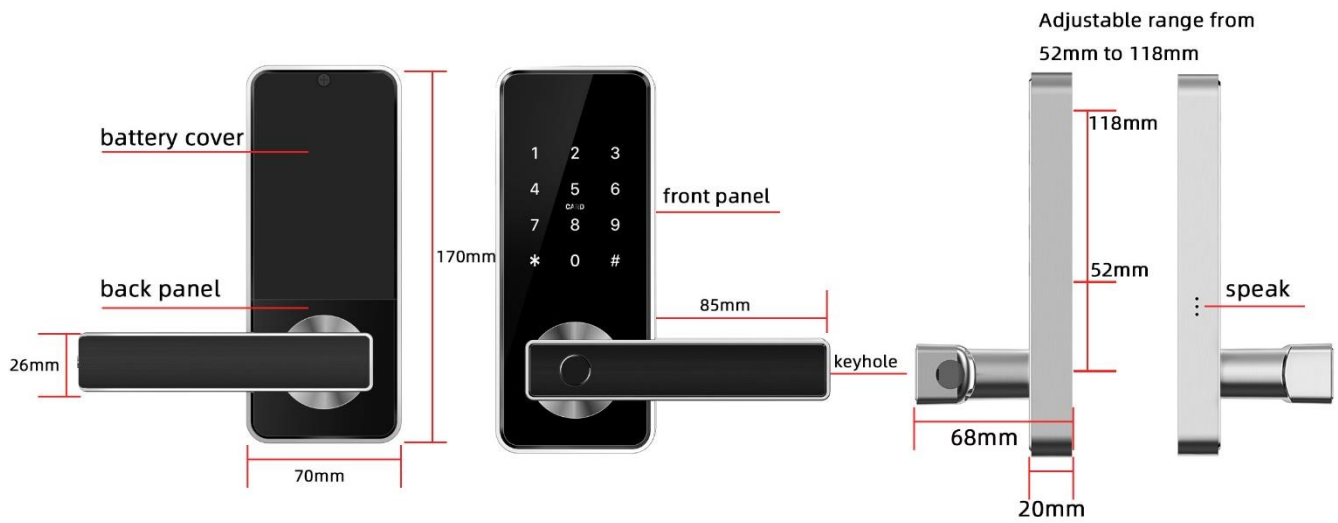

2. Mortise

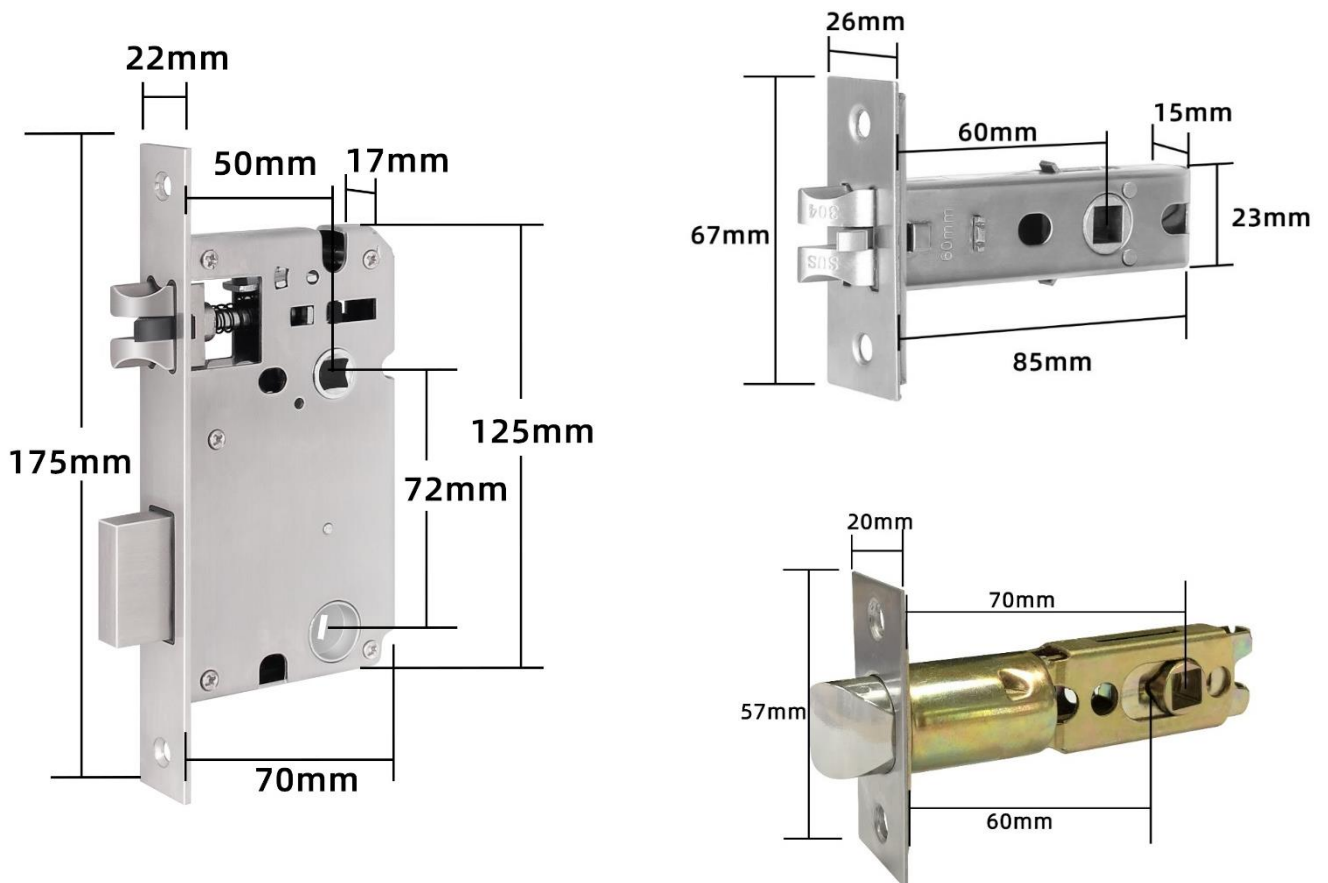

3. Installation

3.1 Turn the handle

Notice: Adjust the handle according to the direction you open the door.

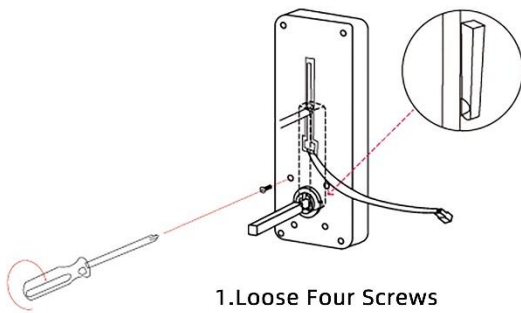

1. Loose Four Screws

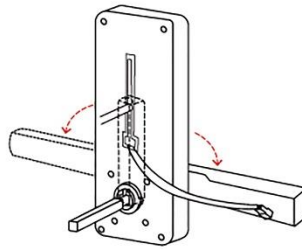

2. Left Open the Handle Toward the Left; Right Open the Handle Toward the Right.

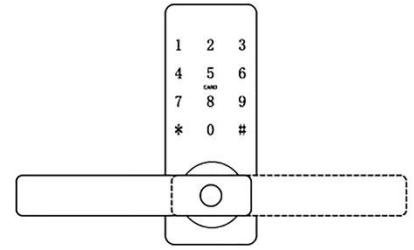

3. Reinstall the Screw After Adjusting the Direction

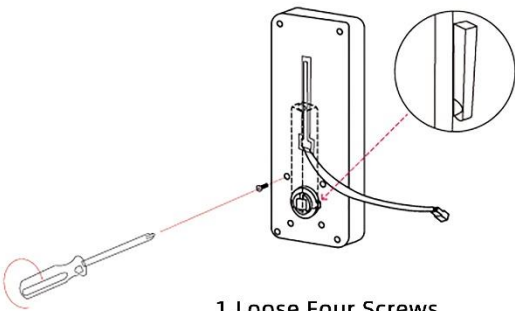

1. Loose Four Screws

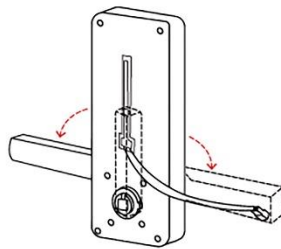

2. Left Open the Handle Toward the Left; Right Open the Handle Toward the Right.

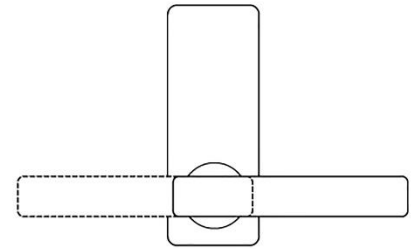

3. Reinstall the Screw After Adjusting the Direction

3.2.1 Installation Diagram (For Latch)

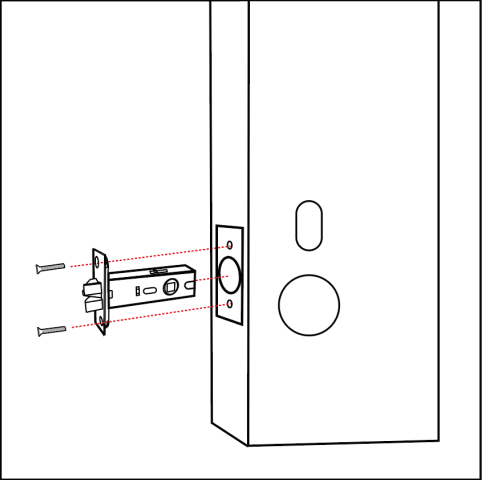
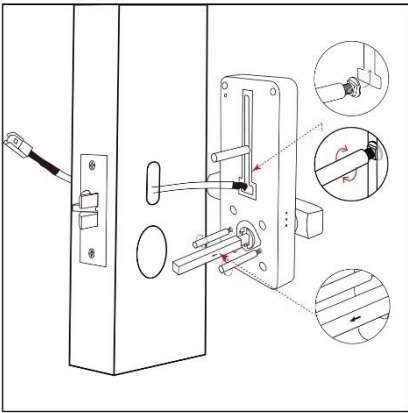
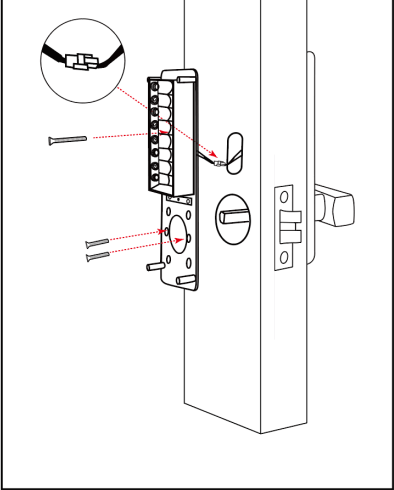
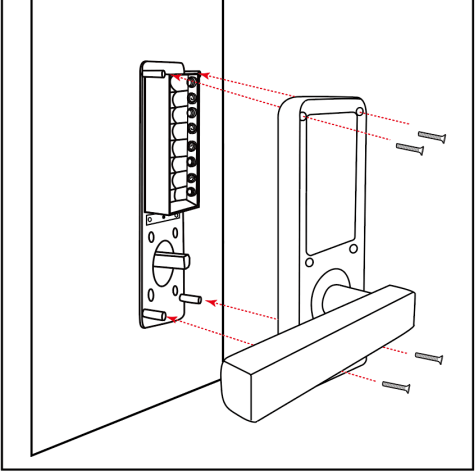
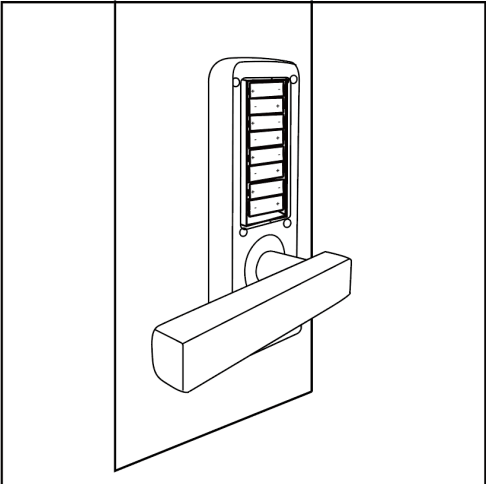
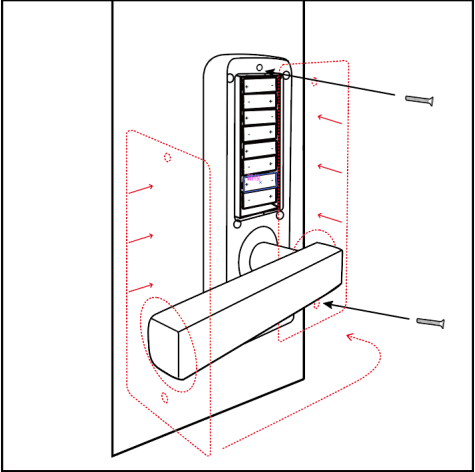
<p>Step 1 Install Mortise</p> 	<p>Step 2 Install Sliding Screw Casing</p>  <ol style="list-style-type: none"> 1. The screw casing place is adjustable from 55mm to 100mm far from the square shaft. 2. Depending on the location of the hole-drilling or the old door hole. 3. Keep arrow direction (shows in image) always facing to the latch
<p>Step 3 Fix Front Panel and Wire</p> 	<p>Step 4 Install Back Panel</p> 
<p>Step 5 Install the Battery</p> 	<p>Step 6 Install the Battery Cover</p> 

3.2.2 Installation Diagram (For 5072)

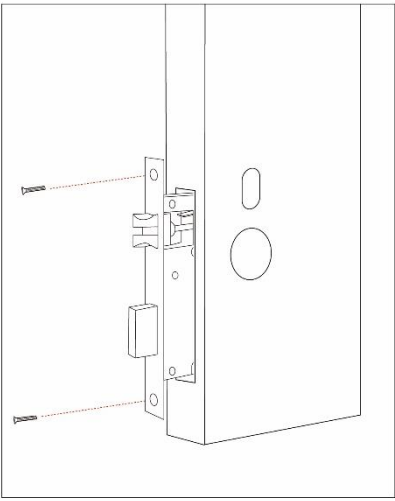
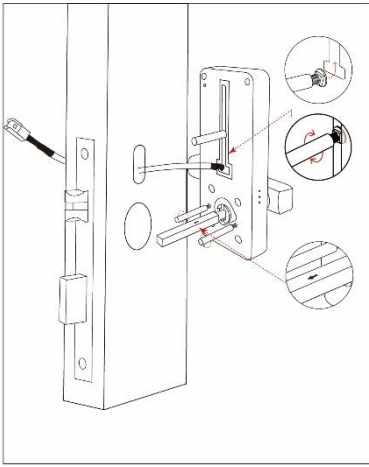
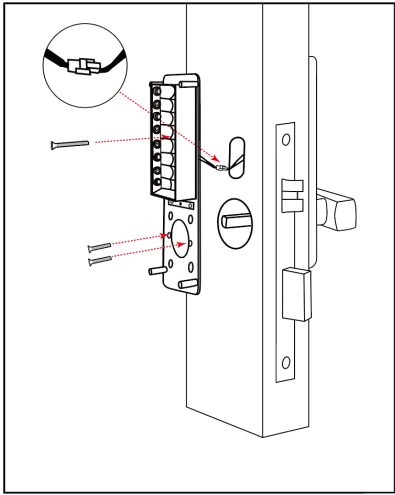
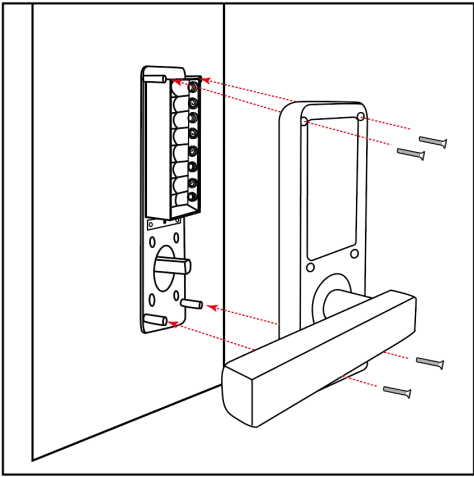
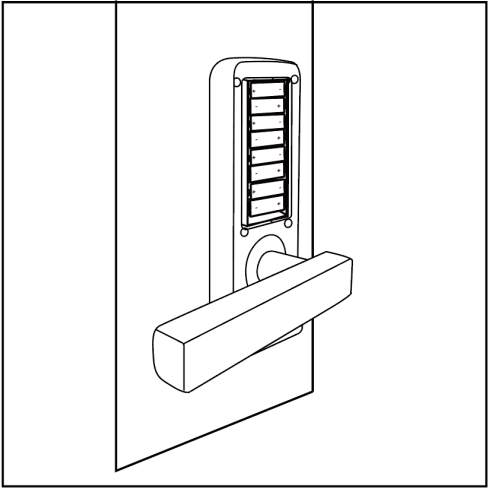
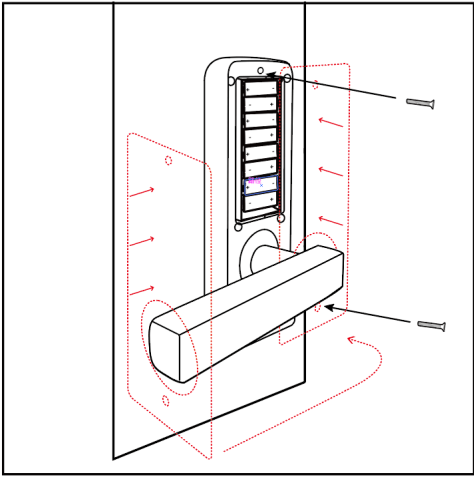
<p>Step 1 Install Mortise</p> 	<p>Step 2 Install Sliding Screw Casing</p>  <ol style="list-style-type: none"> 1. The screw casing place is adjustable from 55mm to 100mm far from the square shaft. <p>Depending on the location of the hole-drilling or the old door hole.</p> <ol style="list-style-type: none"> 2. Keep arrow direction (shows in image) always upward.
<p>Step 3 Fix Front Panel and Wire</p> 	<p>Step 4 Install Back Panel</p> 
<p>Step 5 Install the Battery</p> 	<p>Step 6 Install the Battery Cover</p> 

4. Specifications

Suitable for Models	H11B
Materials	Zinc Alloy
Front Panel Lock Size	170*70*20mm
Back Panel Lock Size	170*70*20mm
Lock Weight	1.5KG
Unlocking Way	Bluetooth Gateway(option) Fingerprint Password Card Mechanical key
Color	Silver Black
Doors Applicable	Aluminum Door Wooden Door
Working Voltage	6V/8x AAA Batteries
Door Thickness to Fit	30-65mm/65-100mm
Data Capacity	150 pcs passcode 200 pcs Card 200 pcs fingerprint
Working Temperature	-25°C-60°C
Working Humidity	20%-90%
Low Wattage Alarm	Less than 4.5V

System Initialization

Open the cover plate of the back panel ,long press the "Reset" button on the back panel for 5s, press "000#",and the initialization is complete



5.Registration



5.1 Connect lock to the phone

- 1) Android mobile phone, please scan the left QR code as above
- 2) Apple mobile phone, please scan the right QR code as above
- 3) You can also search for TTLock in the APP store for download
- 4) Register a new account (phone number or email) or login with an existing account.
- 5) Touch the lock screen to light, click "+ Add Lock"
- 6) The lock nearby will appear on the phone screen, Click "+"
- 7) Re-name the lock
- 8) The lock added successfully

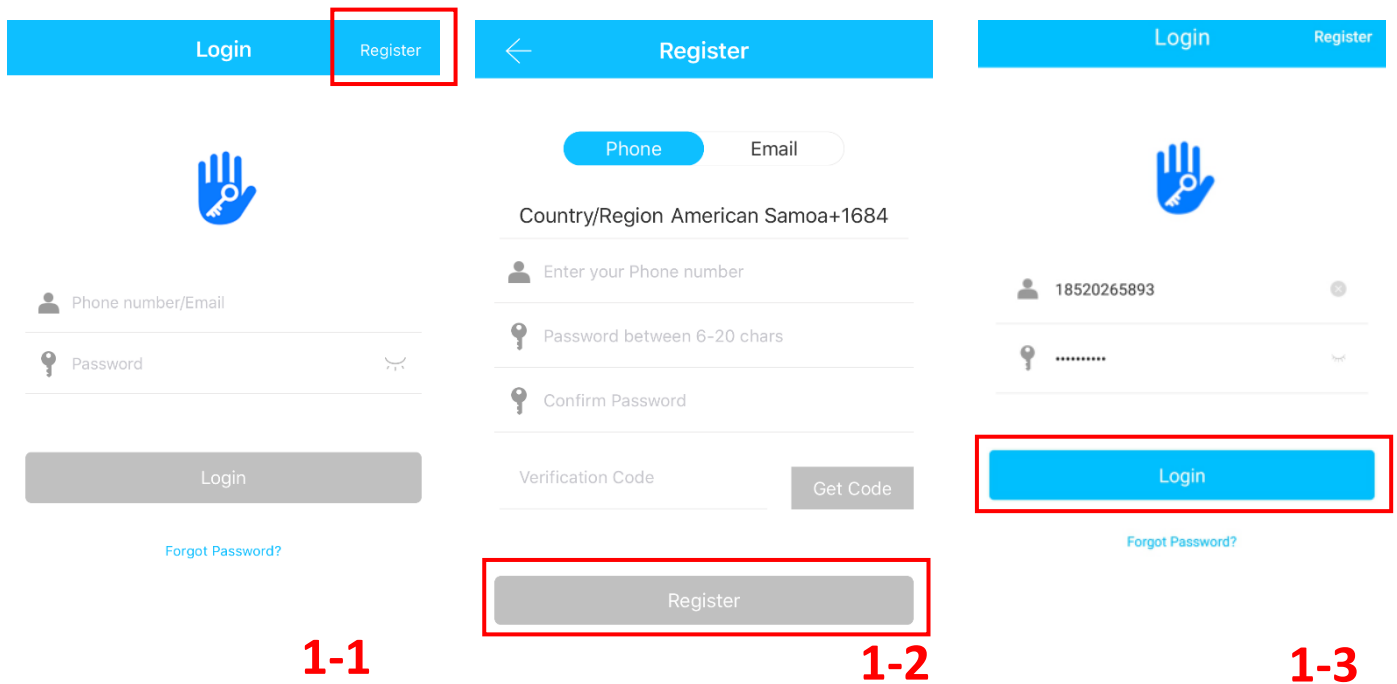

1-1

1-2

1-3

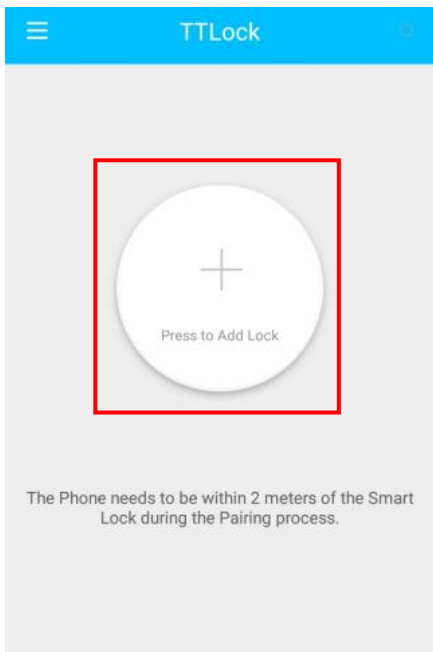

1-4

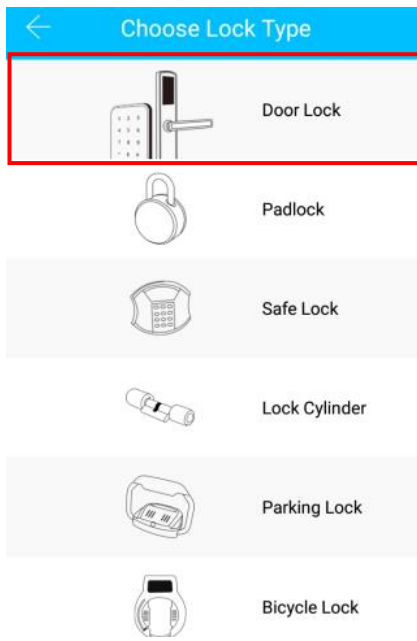

1-5

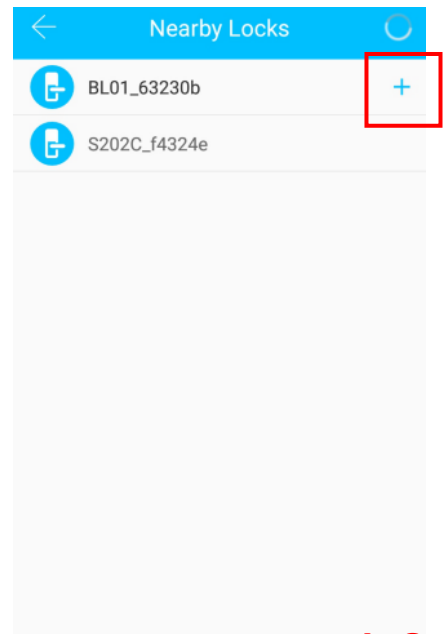

1-6

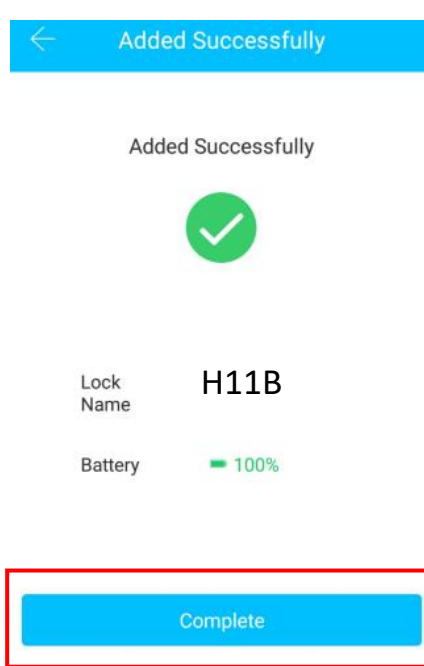
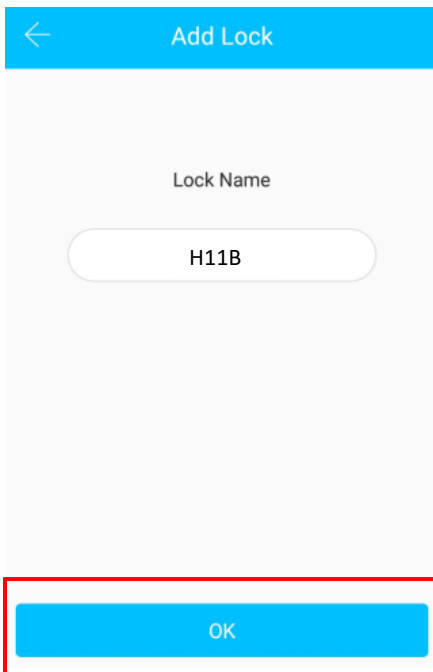

5.2 User Management

5.2.1 Bluetooth management

After mobile phone and door lock connected, Click " " as show as figure2-1 to unlock.(the phone is within 5meters from the door lock)

5.2.2 Remote control management(Optional)

After confirming that your phone and door lock are connected to the gateway, Click " " as show as figure 2-1 to unlock. You can unlock it anywhere you have a network. (How to set up the gateway to connect to your phone refer to step 5.3)

5.2.3 e-Key management

Click on the " Send eKey " as shown in figure 2-1, you can send the eKey to other users of TTlock to authorize the unlock (the receiver must be download the APP and resiter an account) → Enter recipient's account of TTlock, set the name and effective time of the eKey as shown in figure 2-2 → Send → The recipient's account has bluetooth unlock permission

5.2.4 The Admin password management

Click " Settings " as shown in figure 2-1 → See Basic → Admin Passcode as shown in finger2-3 → input Passcode on the keypad of lock → "#" to unlock.



5.2.5 Dynamic password management

Click " Generate Passcode " as shown in finger 2-1 → finger 2-4 You can set the effective time and effective number of passwords → Generate password → Input password to unlock.



5.2.6 Unlock records

Click " Records " as shown in finger 2-1 → you can query your unlock record as shown in finger 2-5

5.2.7 Fingerprint management

Click "  " as shown in finger 2-1 → Click "  " → Add Fingerprint → set the name and effective time of the fingerprint → Start → Place your finger on the sensor follow the instructions → Add fingerprint OK → Place your fingerprint on the sensor to unlock.

5.2.8 IC Cards management

Click "  " as shown in finger 2-1 → Click "  " → Add IC Cards as finger 2-6

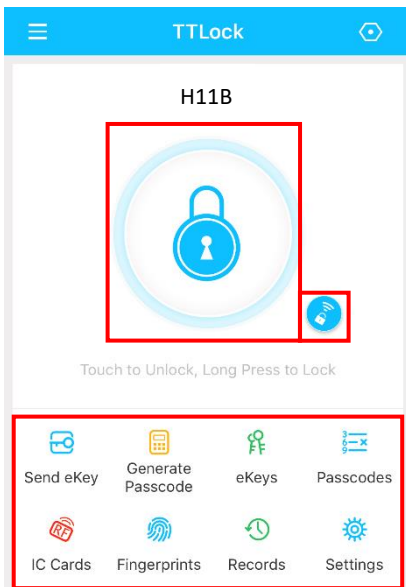

2-1

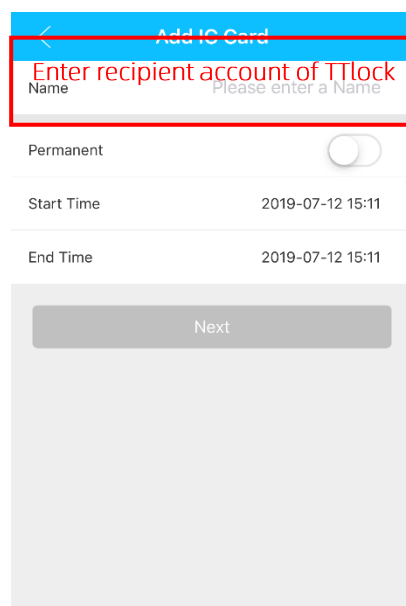

2-2

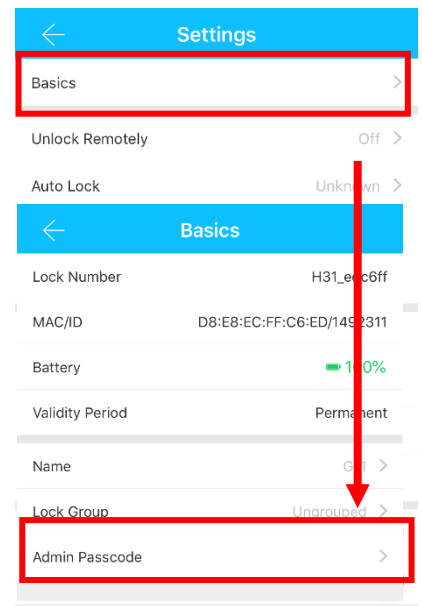

2-3

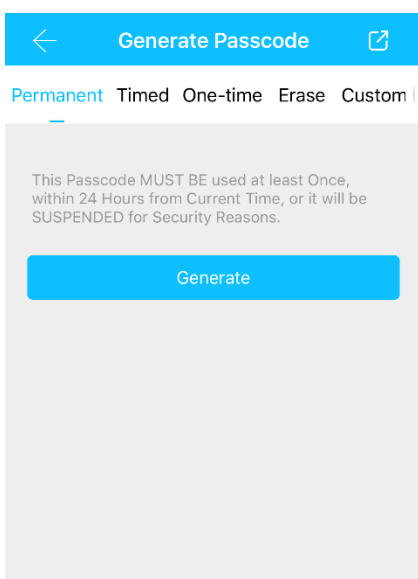

2-4

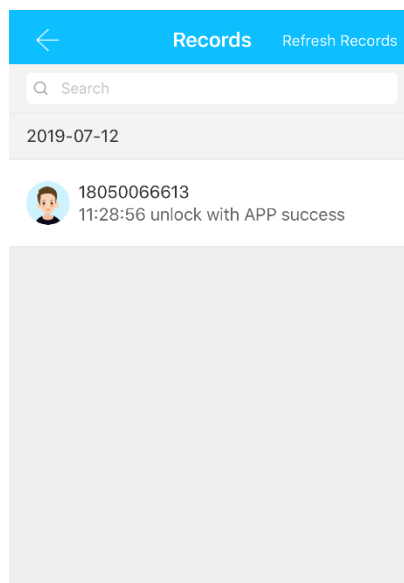

2-5

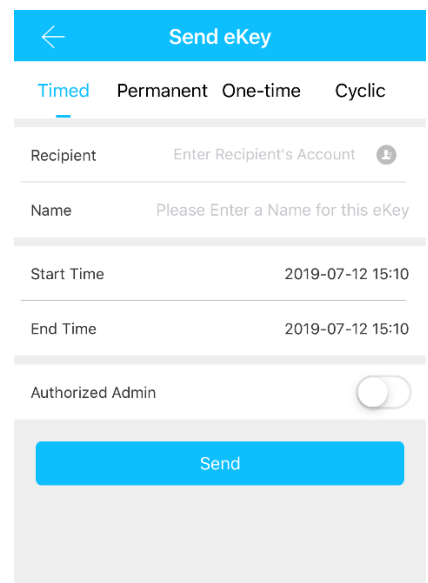



2-6

5.3 Add Gateway(Optional)

Light Status



When the gateway is powered on:

-  Light flashes alternately in red and blue:
Stand-by mode, ready for pairing
-  Blue light: Working mode
-  Red light: Network failure

Pair the Gateway with APP

1 Activate the APP

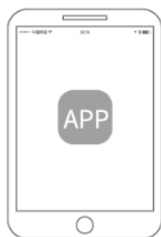

2 Press "☰"

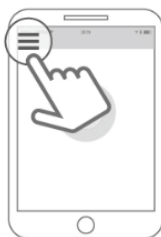

3 Select [Gateway]

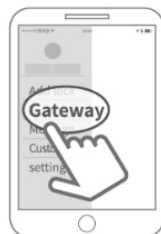

4 Select [G2]

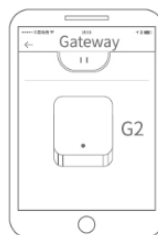

5 Plug in the gateway and power it on, while the light flashes alternately in red and blue

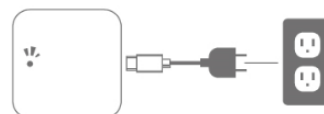

6 Press "+" sign



7 Add Gateway











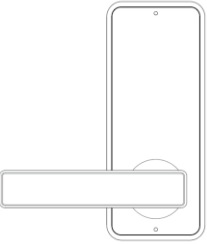
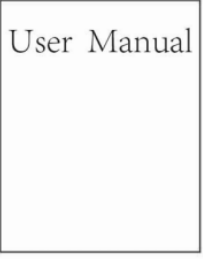
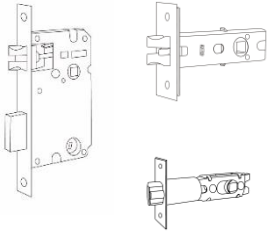
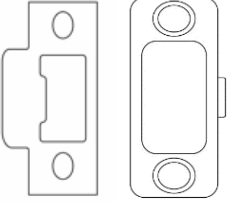

8 Select the network and fill in the password

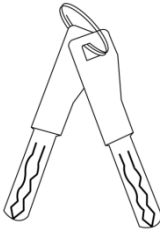

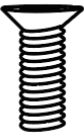
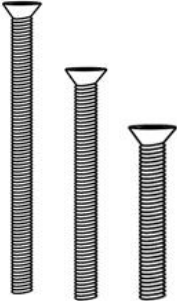
9 Add complete

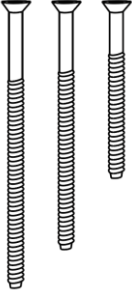
⚠ Notice: If times out, please power off and try it again.

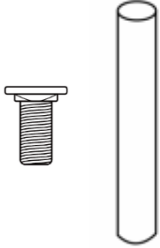
Packing List

Picture				
Name	Front Panel	Back Panel	User Manual	Mortise(3 out of 1)
Quantity	1	1	1	1
Picture				
Name	Strike and Strike Box	Waterproof Rubber Plate	Mechanical Key	Card
Quantity	2*1	2	2	3
Picture				
Name	Fixing screws 1 (For Back Panel)	Opposite Pull Screw 1	Fixing screws 1 (For Aluminum Door)	Pointed Screw (For Wooden Door)
Quantity	6	3*2	4	4
Picture				
Name	Opposite Pull Screw 2	Opposite Pull Screw Casing	Sliding Screw/ Sliding Screw Casing	Gateway
Quantity	3*1	2	2/1	1 (Option)

Guarantee

Customer Name: _____

Customer Calls : _____

Purchase Date : _____

Product Name : _____

Product Model : _____

Note:

- 1) Please keep this card so that you can use it when you need warranty service.
- 2) We provide you with a one-year warranty from the date of purchase.
- 3) This warranty service is valid for customers in any country in the world.